

RAPID Column Formwork

For the highest requirements on concrete surfaces and edge formation

Product Brochure – Issue 10/2017



Content

System advantages	Standard applications
5 For the highest requirements on concrete surfaces and edge formation	12 Concreting platform and ladder access
8 For architectural concrete surfaces without any impressions	13 Moving by crane and tips for the user
9 Also for sharp-edged column cross-sections	
10 Fast basic assembly	

Edition 10/2017

Publisher

PERI GmbH
Formwork Scaffolding Engineering
Rudolf-Diesel-Strasse 19
89264 Weissenhorn
Germany
Phone +49 (0)7309.950-0
Fax +49 (0)7309.951-0
info@peri.de
www.peri.de

Components

14 RAPID Column Formwork

Important information

All current safety regulations and guidelines applicable in those countries where our products are used must be observed.

The images shown in this brochure feature construction sites in progress. For this reason, safety and anchor details in particular cannot always be considered as conclusive or final. These are subject to the risk assessment carried out by the contractor.

In addition, computer graphics are used which are to be understood as system representations. For ensuring a better understanding, these and the

detailed illustrations shown have been partially reduced to show certain aspects. The safety installations which have possibly not been shown in these detailed descriptions must nevertheless still be available. The systems or items shown might not be available in every country.

Safety instructions and load specifications are to be strictly observed at all times. Separate structural calculations are required for any deviations from the standard design data.

The information contained herein is subject to technical changes in the interests of progress. Errors and typographical mistakes reserved.



RAPID Column Formwork

For the highest requirements on concrete surfaces and edge formation

Through a unique clamping principle for the RAPID Column Formwork, the formlining is simply clamped to the frame thus avoiding any nail or screw imprints. With full-surface formlining panels, high quality architectural concrete surfaces can be realized. RAPID is correspondingly designed to accommodate particularly high fresh concrete pressures.



For architectural concrete surfaces without any impressions
with freely-selectable, clamped formlining

Also for sharp-edged column cross-sections
with suitably milled formlining

Fast basic assembly
due to lightweight aluminium panels along with a simple clamping principle for the fixing of formlining

RAPID Column Formwork

For the highest requirements on concrete surfaces and edge formation

Column cross-sections

Continuously adjustable square or rectangular cross-sections of up to 60 cm x 60 cm are possible.

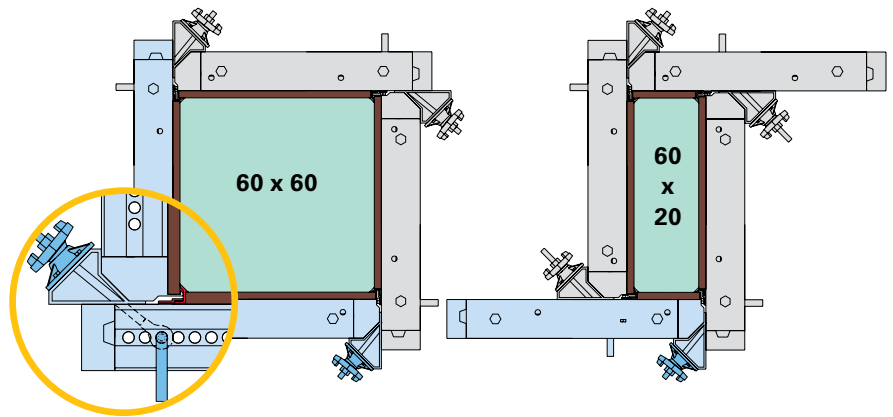

Oversized column cross-sections

Cross-sections from 85 cm x 85 cm up to a maximum of 130 cm x 130 cm are possible. Two column frames are connected using the TRIO Alignment Coupler BFD. A waling with column tie yokes is clamped on to reinforce the formwork.

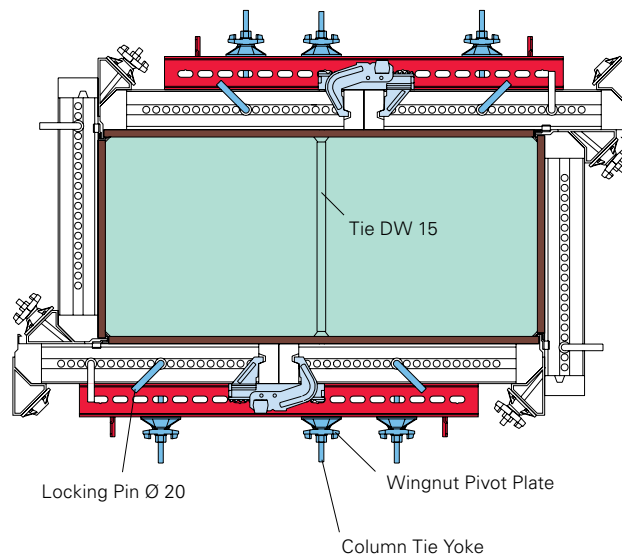

Alignment Coupler BFD
5 per Column Frame 300 4
per Column Frame 210 1 per
Column Frame 60

Steel Waler SRZ 120/U100
4 per Column Frame 300 3
per Column Frame 210 1 per
Column Frame 60

30 cm height increments

The three frame heights of 3.00 m, 2.10 m and 0.60 m, provide ideal height adjustments. The frames are simply screwed together.

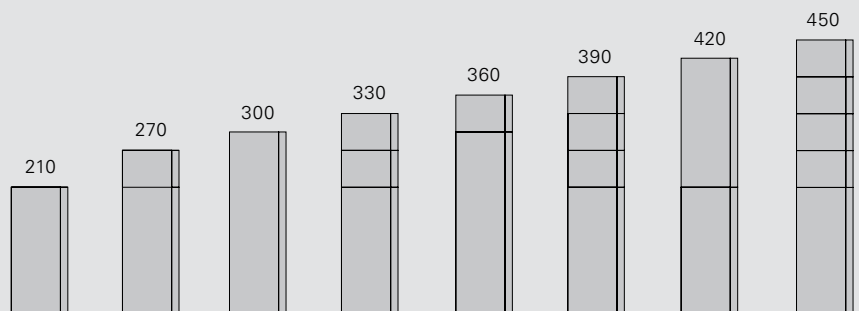

Additional combinations to those shown here are possible.

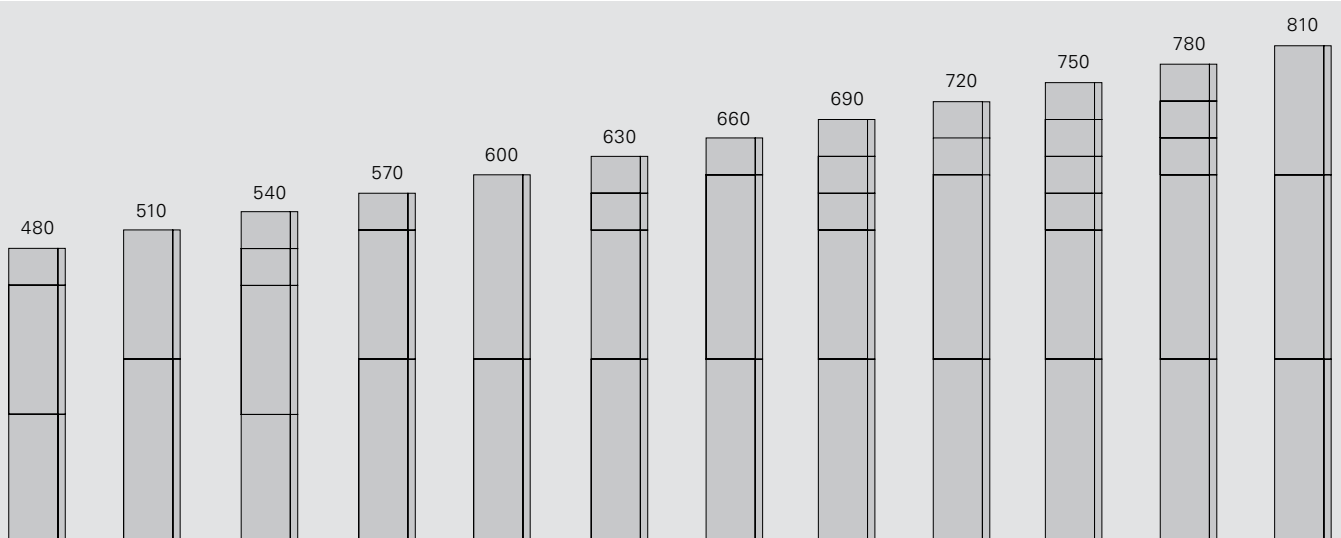

For architectural concrete surfaces without any impressions with freely-selectable, clamped formlining

RAPID clamping principle

The unique PERI RAPID Column Formwork clamping principle eliminates the problems of conventional fixing with nails or screws. The use of formlinings that cover the whole surface in one piece produces concrete surfaces satisfying the most stringent requirements; free from the impressions of screws, nails, formlining points or plugged tie holes.

RAPID Chamfer Strip with the easiest assembly

The clamping principle ensures that the RAPID Chamfer Strip is securely fixed during basic assembly. Without nails!

RAPID Corner Detail – sealed even with high fresh concrete pressure

The captive Chamfer Strip reliably seals the corners. This guarantees a good exposed concrete quality. Honeycombing at the corners is practically eliminated.

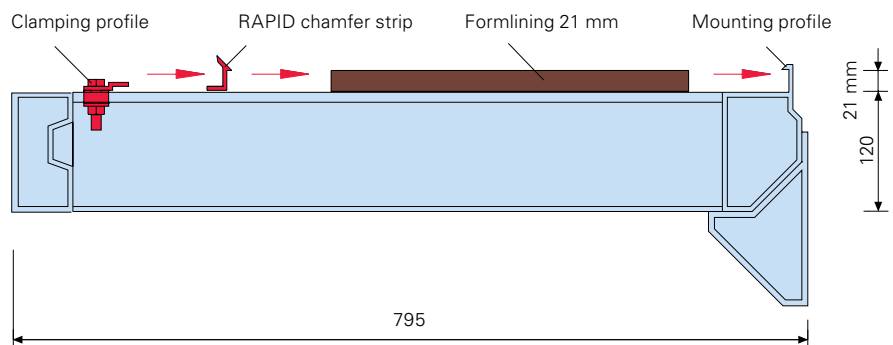

Permissible fresh concrete pressure

The RAPID column has been designed for a very high fresh concrete pressure of 120 kN/m². This allows fast concreting to take place.

Easy to clean

The ECC powder coating guarantees that cleaning is kept to a minimum.

Robust

The robust, practical closed construction of the column frames, allows the PERI RAPID Column Formwork to withstand rough handling.



Also for sharp-edged column cross-sections with suitably milled formlining

Sharp-edged column cross-sections

Even columns without a chamfer strip, repeatedly demanded, can be easily formed with PERI RAPID up to 58 cm x 58 cm.

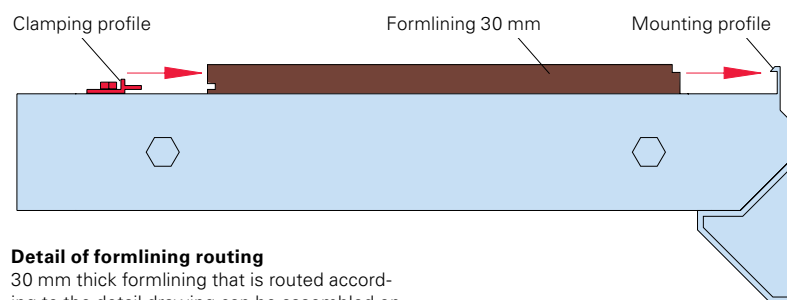

Detail of formlining routing

30 mm thick formlining that is routed according to the detail drawing can be assembled on the column frames without a chamfer strip.

Example 550 mm x 550 mm

Formlining width = column width + 12 mm = 550 + 12 = 562 mm

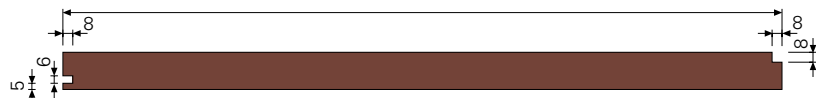

Fast basic assembly

due to lightweight aluminium panels along with a simple clamping principle for the fixing of formlining

The unique PERI RAPID clamping principle

The formlining is clamped onto the frame with a captive chamfer strip and the clamping profile. Basic assembly or replacement of formlining with different sizes is carried out from above, without having to turn the column frame over and without damaging the formlining.

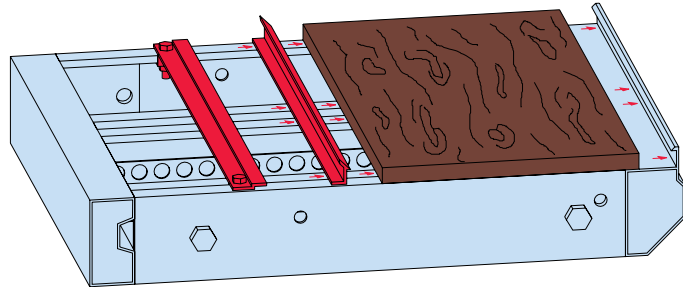

Few individual parts and everything mounted undetachably – time savings with every use

PERI RAPID has no loose components for erection and striking. The formwork is tightened or separated in only a few simple steps. This saves time!

Crane-free basic assembly

The light weight of the PERI RAPID Column Formwork enables basic assembly to be carried out by hand.

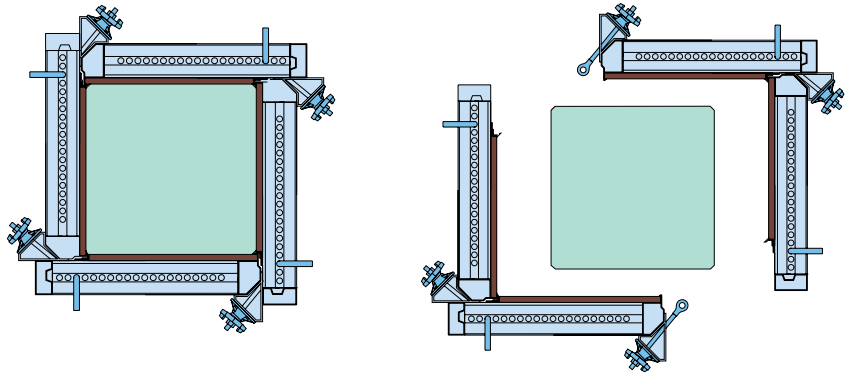

Shuttered

The column frames are delivered complete with clamping profile, column tie yoke, locking pin and spherical nut. There are no small or loose parts that could go astray.

Struck

The corner ties remain on each of the column frames when transporting to the next point of use. No individual components have to be transported to the next location.

Cutting width of formlining

Use a 21 or 22 mm thick formlining of appropriate quality with the main load-bearing direction at column level. Horizontal joints in the formlining must be positioned on frame cross-struts.

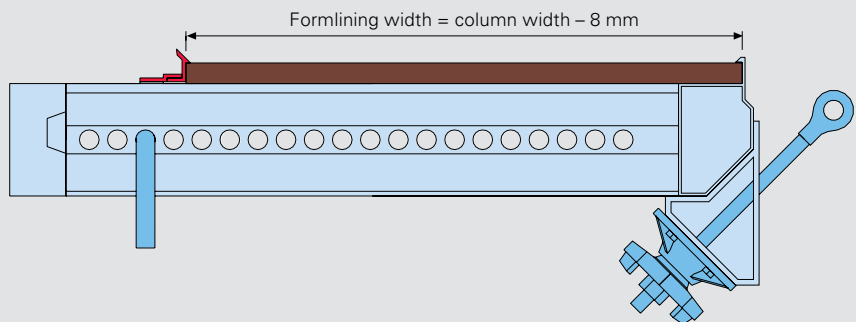

Basic assembly is simple

Everything is assembled horizontally from above, without having to turn the frame over. Place the required column frames on assembly supports and couple lengthwise. For this purpose, each column frame has been fitted with 2 Bolts M20 x 50 (wrench size SW 30) at the factory.

Place the cut-to-size formlining and the RAPID Chamfer Strip on the column frame and tighten together with G clamps. Tighten the clamping rail bolts with SW 17 socket spanner. Secure the formlining with a nail through a hole in the lip of the frame.

Pre-assemble the second frame in the same way. Then place one pre-assembled frame on top of the other and connect with the column tie yokes and spherical nuts to form one half of the formwork.



The RAPID Crane Lifting Unit-2 or the concreting platform is mounted on the horizontally positioned column halves. These parts also serve to protect the formwork against concrete spills.



Concreting platform and ladder access

Concreting platform

The PERI Concreting Platform is delivered to site ready for use:

- No loose parts to get lost, no laborious fitting of separate platform brackets, scaffold boards, handrail boards etc. No more support structure underneath to get in the way.
- The concreting platform fits any ground plan up to 60 x 60 cm.
- The concreting platform is lightweight and can easily be assembled by hand.

11.70 m high RAPID Column. The high permissible fresh concrete pressure makes fast concreting possible.

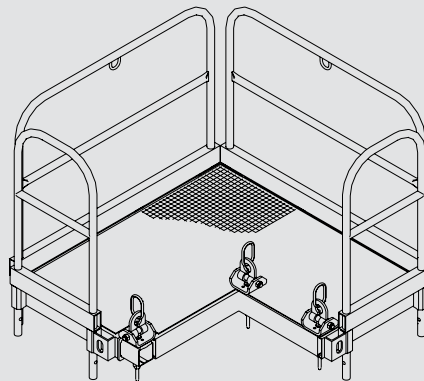

Concreting Platform, complete, Item-no.: 037400. Permissible load of 150 kg/m².



Ladder access

Safe work in any height. RAPID Ladder Access for your safety.

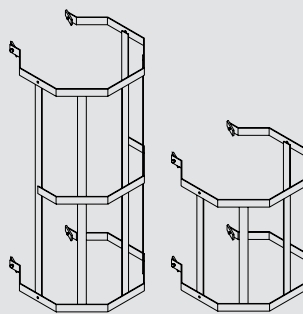

Ladder Safety Cage 150, Item-no.: 051450
Ladder Safety Cage 75, Item-no.: 104132

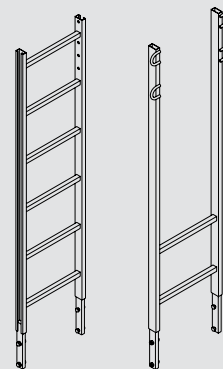

Ladder 180/6, Item-no.: 051410
Access Ladder 180/2, Item-no.: 103724

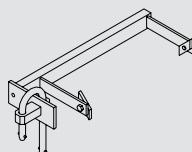

Ladder Connector RAPID, Item-no.: 103369

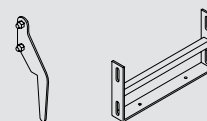

Ladder Hook, Item-no.: 103718
Ladder Base, Item-no.: 051460



Moving by crane and tips for the user

Moving by crane

The connections of the PERI Concreting Platform also serve as crane hooks.

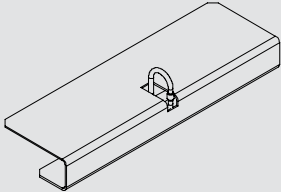

Crane Lifting Unit-2 RAPID, Item-no.: 037320. For moving RAPID Column Formwork.

Complete RAPID Column Formwork half with concreting scaffold and ladder access as well as push-pull props during moving procedure.



Tip for the user

For a precise fixation of the formwork on the slab, we recommend fastening locating boards, set back by the thickness of the formlining "d". The formlining projects about 40 mm beyond the frames at the bottom.

Possible projection of the plywood top

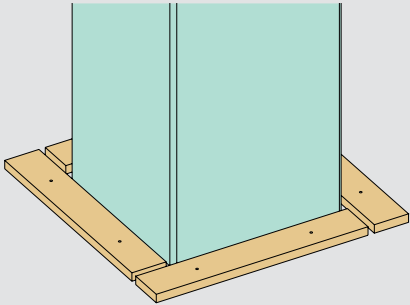
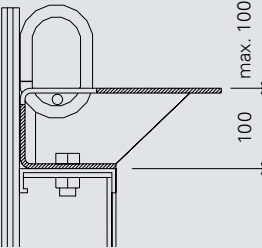

bottom

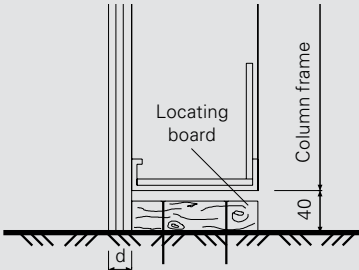

Item no.	Weight kg
037250	61.600

Column Frame RAPID 300, Alu

Column frames for continuously adjustable cross-sections up to 60 x 60 cm. 21 mm plywood thickness. With clamping profile for fixing the plywood without screws or nails.

Complete with

- 4 pc. 037160 Bolt Ø 20 x 205, galv.
- 4 pc. 037150 Tie Yoke DW 15
- 4 pc. 030440 Spherical Nut DW 15, galv.
- 2 pc. 780357 Bolt ISO 4017 M20 x 50-8.8, galv.
- 2 pc. 710334 Nut ISO 4032 M20-8, galv.

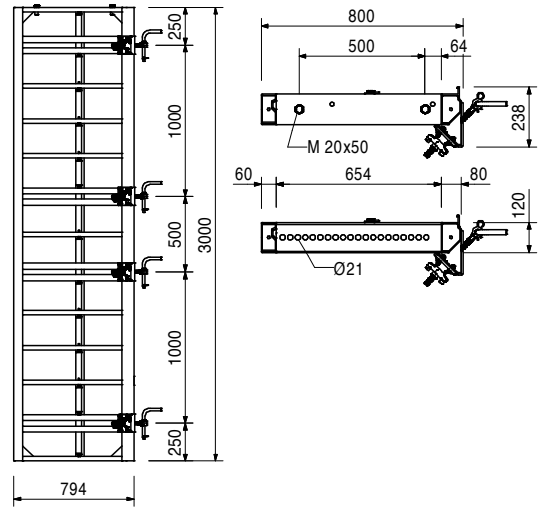
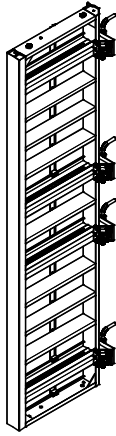

037260	45.100
--------	--------

Column Frame RAPID 210, Alu

Column frames for continuously adjustable cross-sections up to 60 x 60 cm. 21 mm plywood thickness. With clamping profile for fixing the plywood without screws or nails.

Complete with

- 3 pc. 037160 Bolt Ø 20 x 205, galv.
- 3 pc. 037150 Tie Yoke DW 15
- 3 pc. 030440 Spherical Nut DW 15, galv.
- 2 pc. 780357 Bolt ISO 4017 M20 x 50-8.8, galv.
- 2 pc. 710334 Nut ISO 4032 M20-8, galv.

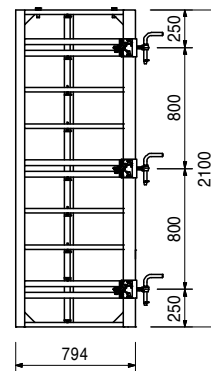
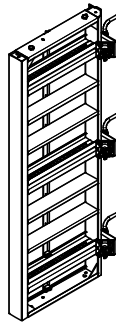

037270	16.800
--------	--------

Column Frame RAPID 60, Alu

Column frames for continuously adjustable cross-sections up to 60 x 60 cm. 21 mm plywood thickness. With clamping profile for fixing the plywood without screws or nails.

Complete with

- 1 pc. 037160 Bolt Ø 20 x 205, galv.
- 1 pc. 037150 Tie Yoke DW 15
- 1 pc. 030440 Spherical Nut DW 15, galv.
- 2 pc. 780357 Bolt ISO 4017 M20 x 50-8.8, galv.
- 2 pc. 710334 Nut ISO 4032 M20-8, galv.

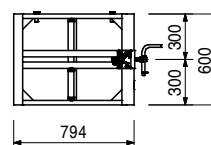
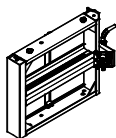

Item no. Weight kg

037150 0.641

Tie Yoke DW 15

For fixing SRZ Steel Walers to the strongback.

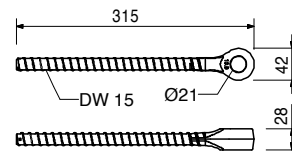

105400 0.330

Pin Ø 20 x 140, galv.

For different connections.

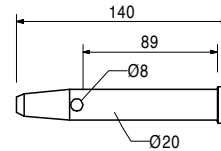
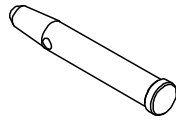

Accessories

018060 0.014

Cotter Pin 4/1, galv.

104477 0.300

Bolt ISO 4014 M20 x 120-8.8, galv.

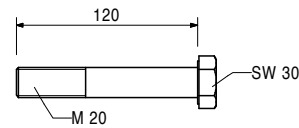
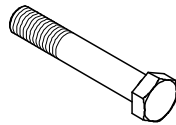

Accessories

781053 0.065

Nut ISO 7040 M20-8, galv.

781053 0.065

Nut ISO 7040 M20-8, galv.

Self-locking.

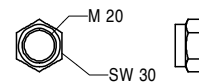

018060 0.014

Cotter Pin 4/1, galv.



Item no.	Weight kg		
037160	0.736	Bolt Ø 20 x 205, galv. For corner tying of the RAPID Column Frames.	Complete with 1 pc. 018060 Cotter Pin 4/1, galv.
030440	0.686	Spherical Nut DW 15, galv. For pivotable anchoring with Tie Rod DW 15 and B 15.	
037210	0.894	Chamfer Strip RAPID, l = 3.0 m For installing the plywood formlining on the RAPID column frame.	
037190	3.010	Brace Connector-3 RAPID, galv. For connecting push-pull props and kicker braces to the RAPID Column Frame.	Complete with 1 pc. 037160 Bolt Ø 20 x 205, galv. 1 pc. 027170 Pin Ø 16 x 42, galv. 2 pc. 018060 Cotter Pin 4/1, galv.

Item no.	Weight kg
037320	16.200

RAPID Crane Lifting Unit-2
For moving RAPID coulumn formwork.

Note
Follow Instructions for Assembly and Use!
Technical Data
Permissible load-bearing point capacity 500 kg.

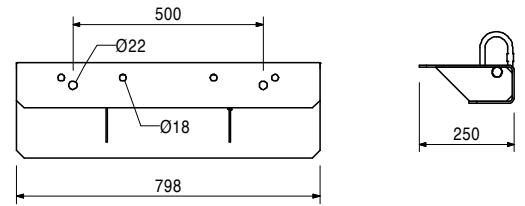
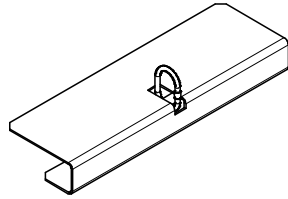

103369	6.400
--------	-------

Ladder Connector RAPID, galv.
For connecting ladders to RAPID column frames.

Complete with
2 pc. 710266 Bolt ISO 4017 M12 x 25-8.8, galv.
2 pc. 701763 Clamping Plate FI 25 x 10 x 90

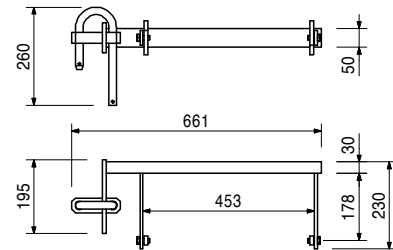
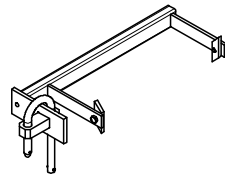

037400	123.000
--------	---------

Concreting Platform, compl.
Working and concreting platform for TRIO, RAPID and QUATTRO Column Formwork.

Complete with
1 pc. 037410 Concreting Landing, Alu
2 pc. 037420 Platform Guardrail 52, galv.
2 pc. 037430 Platform Guardrail 134, galv.
3 pc. 037440 Crane Hook Concreting Platform

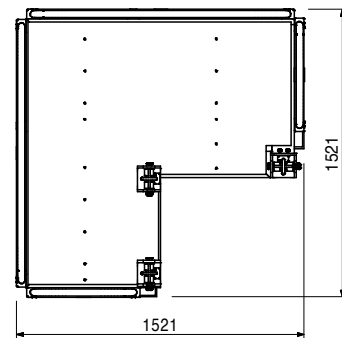
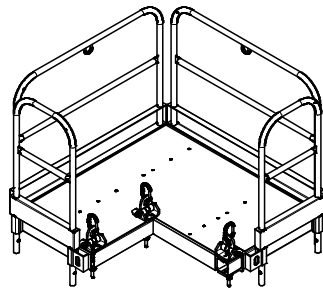

Item no.	Weight kg
037410	51.400

Concreting Landing, Alu

Adjusts continuously to all column cross-sections up to max. 60 x 60 cm. Attachment is carried out using the crane eye of the concreting platform.

Technical Data

Permissible load 150 kg/m².

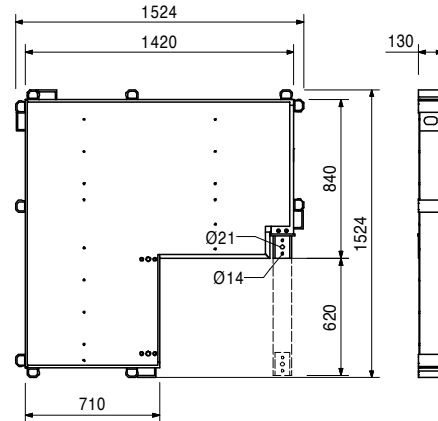
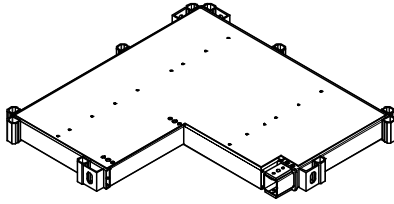

037420	10.200
--------	--------

Platform Guardrail 52, galv.

As guardrail for PERI Concreting Platforms. Locks in place automatically.

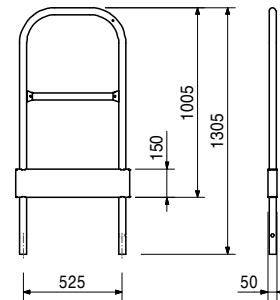
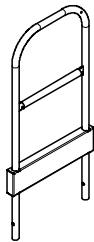

037430	17.100
--------	--------

Platform Guardrail 134, galv.

As guardrail for PERI Concreting Platforms. Locks in place automatically.

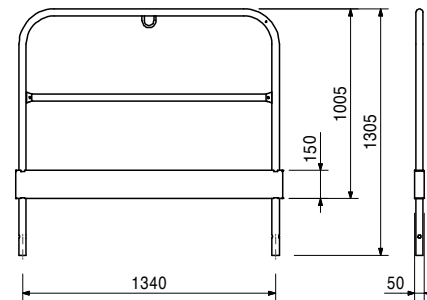
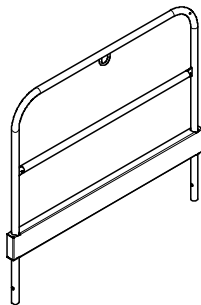

RAPID Column Formwork



Item no.	Weight kg
115352	15.300

Platform Front Guardrail 86/86

As guardrail for PERI Concreting Platforms towards the column. Mounted with Screw-on Coupler.

Note

Wrench size SW 19.

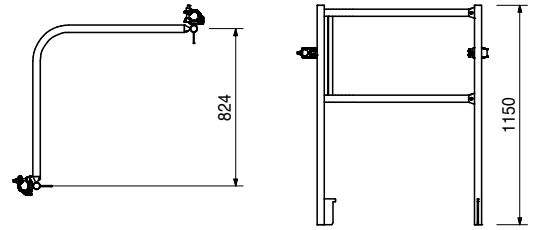
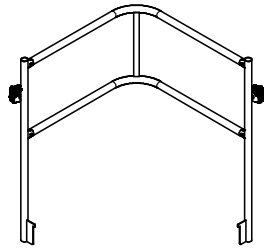

037440	5.640
--------	-------

Crane Hook Concreting Platform

For assembling the concreting landing to the TRIO, RAPID and QUATTRO column frames.

Note

Follow Instructions for Assembly and Use!

Technical Data

Permissible load-bearing capacity 1.0 t.

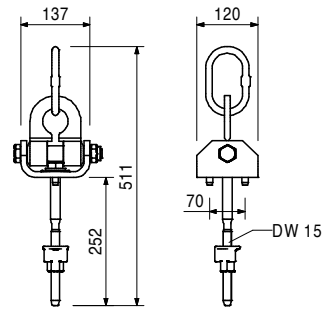
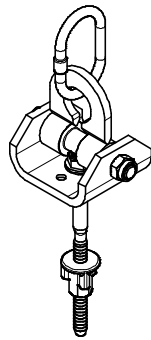

051460	2.180
--------	-------

Ladder Base, galv.

As bottom ladder connection and for securing ladders against sliding on the scaffold decks.

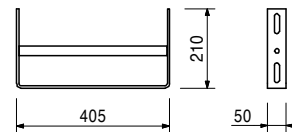
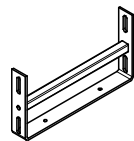

051410	11.700
--------	--------

Ladder 180/6, galv.

As access for PERI Formwork Systems.

Complete with

4 pc. 710224 Bolt ISO 4017 M12 x 40-8.8, galv.

4 pc. 710381 Nut ISO 7042 M12-8, galv.

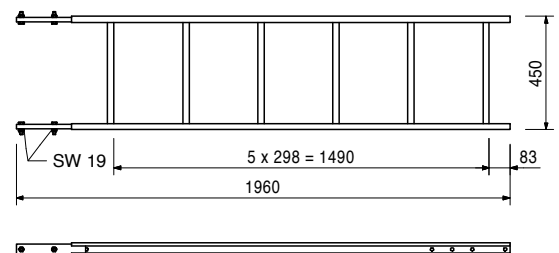
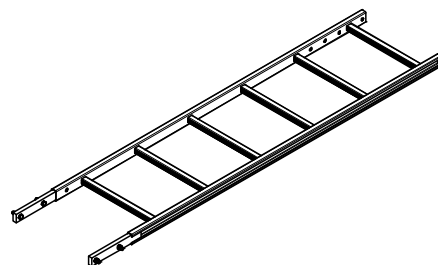

Item no.	Weight kg
103724	10.400

End Ladder 180/2, galv.
As access for PERI Formwork Systems.

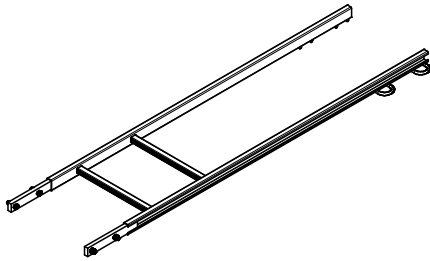

Complete with
4 pc. 710224 Bolt ISO 4017 M12 x 40-8.8, galv.
4 pc. 710381 Nut ISO 7042 M12-8, galv.

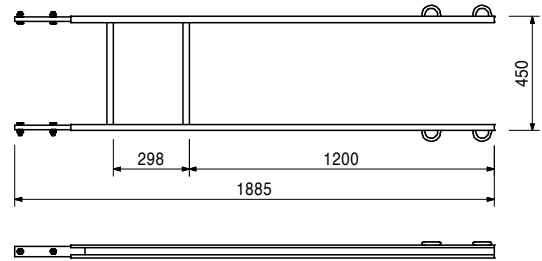

104132	15.600
051450	25.200

Ladder Safety Cages, galv.
Ladder Safety Cage 75, galv.
Ladder Safety Cage 150, galv.
Ladder safety cage for PERI Access Ladders.

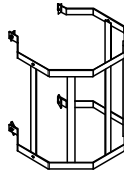

Complete with
4 pc. 710266 Bolt ISO 4017 M12 x 25-8.8, galv.
4 pc. 701763 Clamping Plate FI 25 x 10 x 90

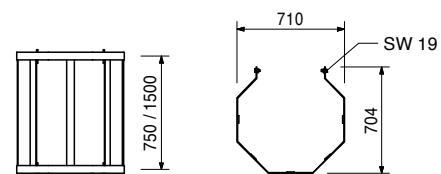

103718	0.684
--------	-------

Ladder Hook, galv.
For adjusting the bottom ladder.
Always use in pairs.



Complete with
2 pc. 710266 Bolt ISO 4017 M12 x 25-8.8, galv.
2 pc. 710381 Nut ISO 7042 M12-8, galv.

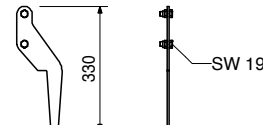

117466	10.600
--------	--------

Push-Pull Prop RS 210, galv.
Extension length $l = 1.30 - 2.10$ m.
For aligning PERI Formwork Systems and precast concrete elements.

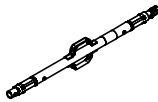

Note
Permissible load see PERI Design Tables.

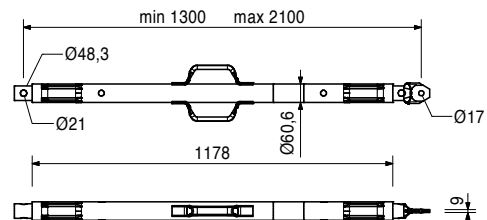

RAPID Column Formwork

Item no.	Weight kg
118238	12.100

Push-Pull Prop RS 260, galv.

Extension length $l = 2.30 - 2.60$ m.
For aligning PERI Formwork Systems and precast concrete elements.

Note

Permissible load see PERI Design Tables.

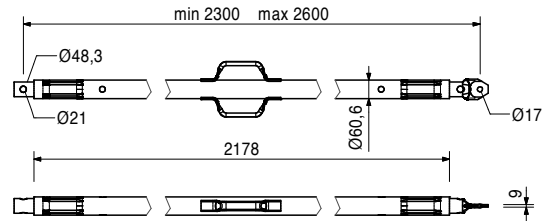
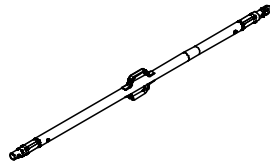

117467	15.500
--------	--------

Push-Pull Prop RS 300, galv.

Extension length $l = 1.90 - 3.00$ m.
For aligning PERI Formwork Systems and precast concrete elements.

Note

Permissible load see PERI Design Tables.

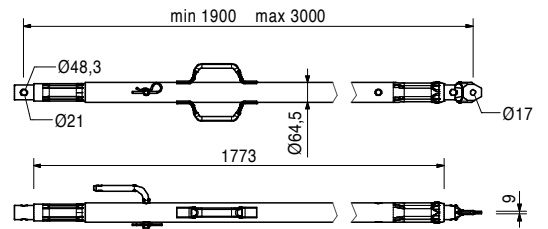
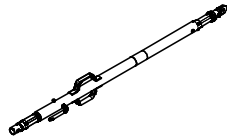

117468	23.000
--------	--------

Push-Pull Prop RS 450, galv.

Extension length $l = 2.80 - 4.50$ m.
For aligning PERI Formwork Systems and precast concrete elements.

Note

Permissible load see PERI Design Tables.

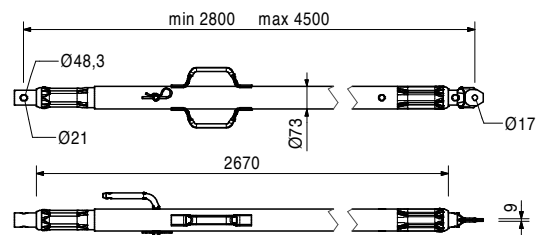
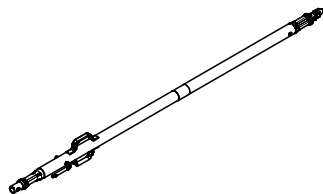

117469	39.900
--------	--------

Push-Pull Prop RS 650, galv.

Extension length $l = 4.30 - 6.50$ m.
For aligning PERI formwork systems and precast concrete elements.

Note

Permissible load see PERI Design Tables.

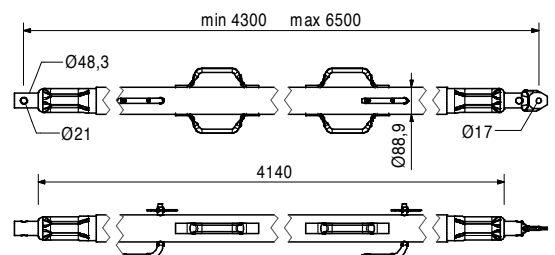
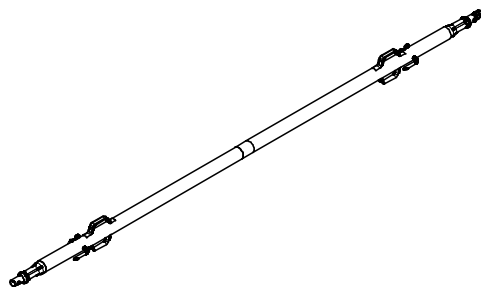

Item no.	Weight kg
028990	115.000

Push-Pull Prop RS 1000, galv.
 Extension length $l = 6.40 - 10.00$ m.
 For aligning PERI formwork systems.

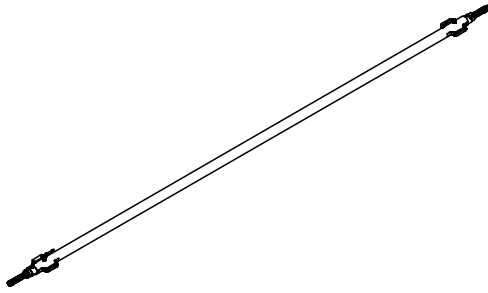

Note
 Permissible load see PERI Design Tables.

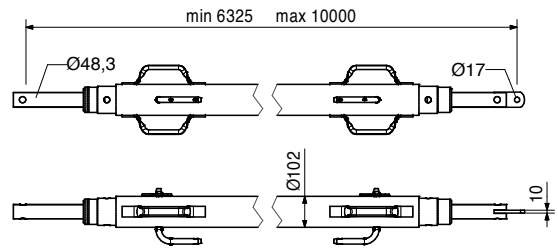

103800	271.000
--------	---------

Push-Pull Prop RS 1400, galv.
 Extension length $l = 6.40 - 14.00$ m.
 For aligning PERI formwork systems.

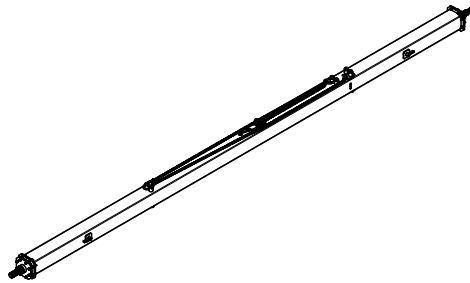

Note
 Permissible load see PERI Design Tables.
 Chain can be operated from bottom.

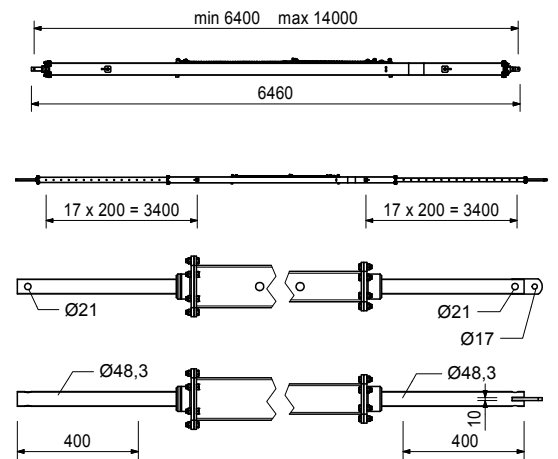

126666	3.070
--------	-------

Base Plate-3 for RS 210 - 1400
 For assembly of Push-Pull Props RS 210, 260, 300, 450, 650, 1000 and 1400.

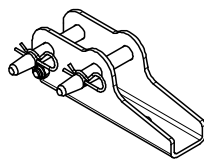

Complete with
 2 pc. 105400 Pin $\varnothing 20 \times 140$, galv.
 2 pc. 018060 Cotter Pin 4/1, galv.
 1 pc. 113063 Bolt ISO 4014 M12 $\times 80-8.8$, galv.
 1 pc. 113064 Hex Nut ISO7042-M12-8-G, galv.

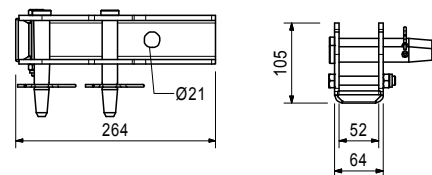

Accessories

124777	0.210
--------	-------

Anchor Bolt PERI 14/20 x 130

Item no.	Weight kg
102018	4.880

Base Plate-2 for RS 1000/1400, galv.

For assembly of Push-Pull Props RS 210, 260, 300, 450, 650, 1000, 1400 and Heavy Duty Spindles.

Complete with

2 pc. 105400 Pin Ø 20 x 140, galv.
2 pc. 018060 Cotter Pin 4/1, galv.

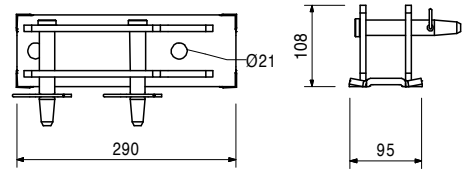
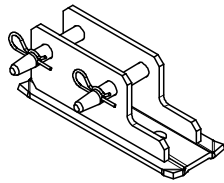

117343	3.250
--------	-------

Base Plate-2 for RS 210 - 1400, galv.

For assembly of Push-Pull Props RS 210, 260, 300, 450, 650, 1000 and 1400.

Complete with

2 pc. 105400 Pin Ø 20 x 140, galv.
2 pc. 018060 Cotter Pin 4/1, galv.

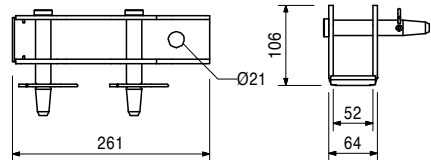
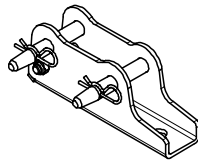

Accessories

124777	0.210
--------	-------

Anchor Bolt PERI 14/20 x 130

Push-Pull Prop RSS I

Extension length l = 2.05 – 2.94 m.
For aligning PERI Formwork Systems.

Note

Permissible load see PERI Design Tables.

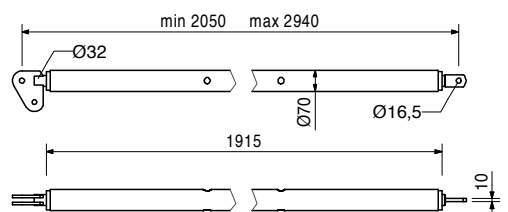
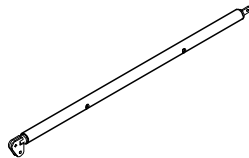

Accessories

113397	1.600
--------	-------

Spindle Handle RSS / AV

113397	1.600
--------	-------

Spindle Handle RSS / AV

Spindle handle for screwing on Push-Pull-Props RSS I, RSS II and Kickers AV 210 and AV RSS III.

Complete with

2 pc. 722342 Screw ISO 4017 M8 x 25-8.8, galv.
2 pc. 711071 Nut ISO 7042 M8-8, galv.

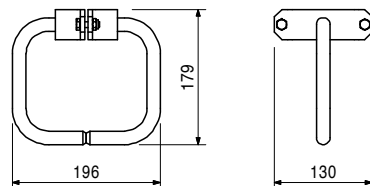
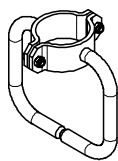

Item no.	Weight kg
028020	22.000

Push-Pull Prop RSS II

Extension length $l = 2.91 - 3.80$ m.
For aligning PERI Formwork Systems.

Note

Permissible load see PERI Design Tables.

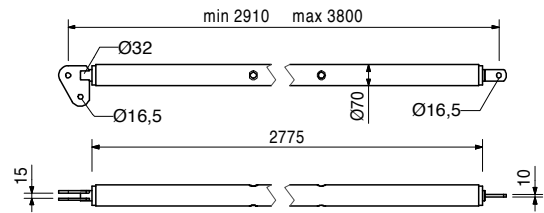
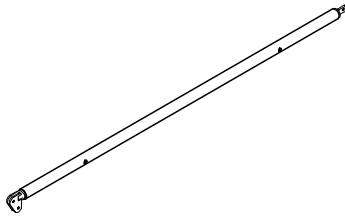

Accessories

113397	1.600
--------	-------

Spindle Handle RSS / AV

028030	38.400
--------	--------

Push-Pull Prop RSS III

Extension length $l = 4.60 - 6.00$ m.
For aligning PERI formwork systems.

Note

Permissible load see PERI Design Tables.

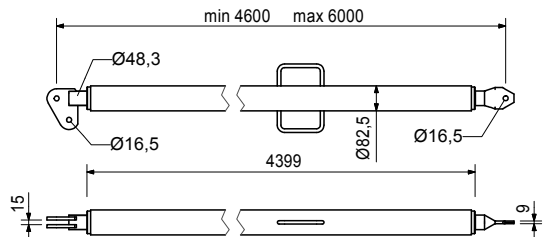
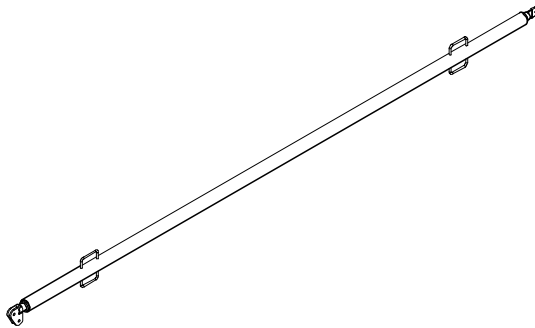

106000	1.820
--------	-------

Base Plate-2 for RSS, galv.

For assembly of Push-Pull Props RSS.

Complete with

- 1 pc. 027170 Pin $\varnothing 16 \times 42$, galv.
- 1 pc. 018060 Cotter Pin 4/1, galv.

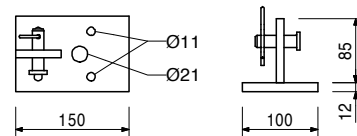
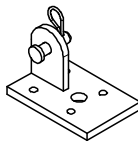

Accessories

124777	0.210
--------	-------

Anchor Bolt PERI 14/20 x 130

Item no.	Weight kg
057087	3.510
057088	4.200

Kickers AV
Kicker AV 82
Kicker AV 111
 For aligning PERI Formwork Systems.

min. L	max. L
500	820
790	1110

Complete with
 1 pc. 027170 Pin Ø 16 x 42, galv.
 1 pc. 018060 Cotter Pin 4/1, galv.

Note
 Permissible load see PERI Design Tables.

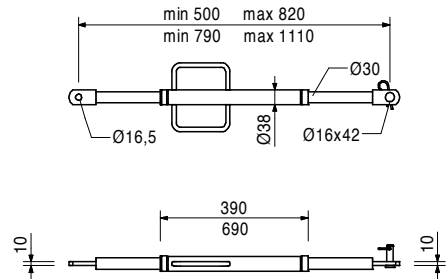
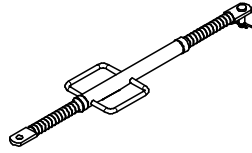

028110	4.850
--------	-------

Kicker AV 140
 Extension length l = 1.08 – 1.40 m.
 For aligning PERI Formwork Systems.

Complete with
 1 pc. 027170 Pin Ø 16 x 42, galv.
 1 pc. 018060 Cotter Pin 4/1, galv.

Note
 Permissible load see PERI Design Tables.

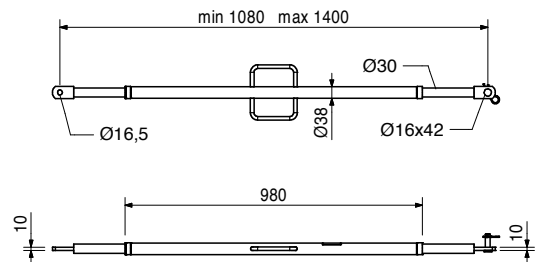
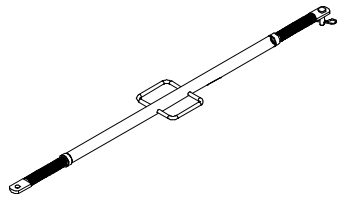

108135	12.900
--------	--------

Kicker AV 210
 Extension length l = 1.28 – 2.10 m.
 For aligning PERI Formwork Systems.

Complete with
 1 pc. 027170 Pin Ø 16 x 42, galv.
 1 pc. 018060 Cotter Pin 4/1, galv.

Note
 Permissible load see PERI Design Tables.

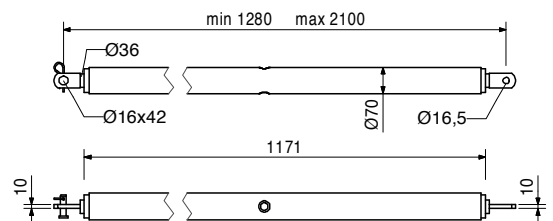
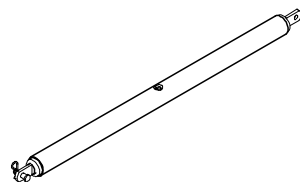

113397	1.600
--------	-------

Accessories
Spindle Handle RSS / AV

Item no.	Weight kg
028120	17.000

Kicker AV RSS III

Extension length l = 2.03 – 2.92 m.
For aligning PERI formwork systems.

Complete with

1 pc. 027170 Pin Ø 16 x 42, galv.
1 pc. 018060 Cotter Pin 4/1, galv.

Note

Permissible load see PERI Design Tables.

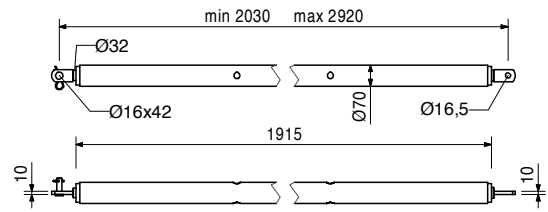
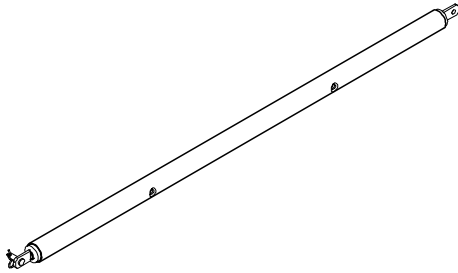

Item no.	Weight kg
113397	1.600

Accessories

Spindle Handle RSS / AV

028080	2.970
--------	-------

Connector Kicker/Push-Pull Prop, galv.

For connecting push-pull props and kicker braces to Main Beam HDT.

Complete with

1 pc. 018060 Cotter Pin 4/1, galv.
1 pc. 027170 Pin Ø 16 x 42, galv.

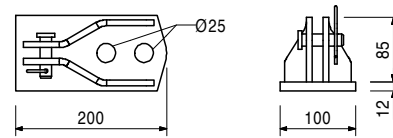
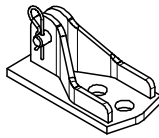

124777	0.210
--------	-------

Anchor Bolt PERI 14/20 x 130

For temporary fixation to reinforced concrete structures.

Note

See PERI data sheet!
Drilling Ø 14 mm.

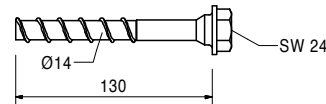
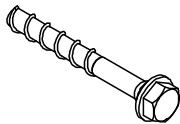

**The optimal System
for every Project and
every Requirement**



Wall Formwork



Column Formwork



Slab Formwork



Climbing Systems



Bridge Formwork



Tunnel Formwork



Shoring Systems



Construction Scaffold



Facade Scaffold



Industrial Scaffold



Access



Protection Scaffold



Safety Systems



**System-Independent
Accessories**



Services



PERI GmbH
Formwork Scaffolding Engineering
 Rudolf-Diesel-Strasse 19
 89264 Weissenhorn
 Germany
 Tel. +49 (0)7309.950-0
 Fax +49 (0)7309.951-0
 info@peri.com
 www.peri.com

